

User Manual

NSC 100 HT Canadian

© Nyle Systems LLC
NSC100 HT Canadian Manual Version 1.2

 Nyle Systems

12 Stevens Rd

Brewer, ME 04412

 www.nyle.com

 info@nyle.com

 800-777-6953

Table of Contents

Safety Guidelines.....	1
Precautions.....	1
Electrical Grounding.....	1
General Control Information.....	2
PLC Modules.....	2
HMI Touch Screen Interface.....	2
Web Server and Remote Access.....	2
Starting a Typical Drying Cycle.....	2
Screens.....	2
Data Logging	3
Starting a Data Log	3
Retrieving a Data Log	3
Input Control Wiring.....	4
Output Control Wiring.....	5
RTD Wiring	6
Service Log	7

⚠️ WARNING

Read through entire manual before installing, operating, or servicing this unit.

Failure to follow any steps or guidelines could result in personal injury, death, destruction of property or may cause the unit to become inoperable. **This manual must be kept with the unit at all times.**

Safety Guidelines

Precautions

Do not operate unit if it or any of its parts:

- Have been exposed to fire.
- Have been submerged in water or exposed to flooding.
- Have significant interior or exterior damage.

In the case of any of the above, have the unit serviced by a qualified professional before continuing operation.

Electrical Grounding

Unit must be grounded.

Failure to ground will result in unreliable performance or an inoperative unit. Ground by connecting unit to a grounded metal, permanent wiring system. Grounding must be in accordance with national and local electrical codes. Please contact your municipal offices for more information on building codes.

⚠️ WARNING

High Temperatures!

- Kiln chamber can reach internal temperatures of over 90°F. working in these temperatures can cause heat stroke and minor burns.
- Pregnant women, children, the elderly and those with significant health issues are at higher risk of heat stroke and must be supervised in high temperatures.
- Kiln operators should check for temperature and take proper safety precautions before entering the kiln chamber.



⚠️ WARNING

Electrical Shock!

- **Turn off power to unit before service.**
- Make sure wires are labeled before disconnecting.
- Test unit after reconnecting wires.
- Failure to do the above could result in death or injury.

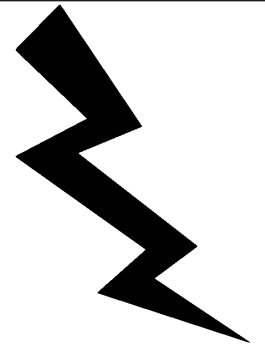

⚠️ WARNING

Explosion Hazard!

- **DO NOT** purge or pressurize this system with oxygen to test for leakage. Using oxygen may cause explosive reaction.

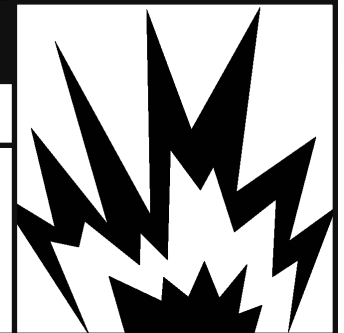

General Control Information

PLC Modules

The NHT100 advanced control system uses a Siemens based S7-1200 PLC controller with built-in Ethernet switch, 24VDC power supply and RTD based temperature module. The HMI contains an SD data card and is used to store data logs for each kiln cycle. The data logs are accessible via a LAN connection through the built-in web server that runs on the PLC.

HMI Touch Screen Interface

The NHT100 advanced control system uses a 4" color touch screen control as the main interface for operating the kiln chamber. The HMI touch screen is capable of performing all kiln operations including managing schedules, setting up data logs, reading trends, monitoring status and more.

nyle systems		Cycle Stopped		12/12/2017 12:20:37 PM	
STATUS	STOPPED	SETPOINTS	ACTUAL		
FAN	IDLE	DRYBULB 30 °C	FWD DB	40.0 °C	
HEAT	STANDBY	WETBULB 20 °C	REV DB	50.0 °C	
VENT	CLOSED	WOOD PROBE 15 °C	WETBULB 1	30.0 °C	
			WETBULB 2	30.0 °C	
			WP1	20.0 °C	
STEP: 1	TIME REMAINING: 0 Min(s)	RUN ●	DONE ●	SCHEDULE	
ELAPSED HT TIME: 0 Day(s) 0 Hour(s) 0 Min(s)		SETTINGS		START	
CYCLE START TIME: 1/1/1970 12:00:00 AM					
CYCLE RUNTIME: 0 Day(s) 0 Hour(s) 0 Min(s)					

Web Server and Remote Access

The NHT100 advanced control offers a state of the art web server control. Many PLCs offer a web server, but with the NHT100 full control capabilities are also enabled. Kiln operators can use the built in web server to monitor all kiln conditions on any kiln that is connected to the LAN. With very little effort, this web server can also be accessed via the web on cell phones or home computers.

Each kiln is accessible via IP address which is typically assigned in the factory. For information on changing the default IP addresses or help with port forwarding please call Nyle at 800-777-6953.

Example IP addresses for kiln are 192.168.1.71 for the PLC and 192.168.1.81 for the HMI interface.

Starting a Typical Drying Cycle

1. Start at the Home Screen
2. Choose SETTINGS --> Set the desired setpoints for the wetbulb and drybulb.
3. In SETTINGS --> Set the equipment for either auto, manual, off, forward or reverse.
4. Press START

Screens

The **Home** screen is the first screen on the HMI control. You may return to the home screen at any point by simply pressing on the button that reads "home". The home screen is used to display the current temperatures / conditions inside the kiln, current Lot ID, time remaining, and cycle status. From the home screen the operator can navigate to the other 2 branches inside the control layout. The user can access the Schedule and Settings screen from the home screen.

The **Settings** screen is where the user will go to setup the fans, heat, vent and drying mode. The Settings section is a helpful interface for viewing what is happening with your kiln. On this screen, displayed is the equipment and allows you to change the operation of it. The user can change the amount of hours that the forward fan and reversing fan will run for. This is also where you will navigate to change the Drybulb and Wetbulb setpoint. From this screen. You can navigate to the Trends screen, Diagnostics screen and the Home screen.

nyle systems		Cycle Stopped		12/12/2017 12:23:54 PM	
EDIT		Nyle		SETPOINTS	
EQUIPMENT					
FAN	IDLE	OFF	FWD	REV	AUTO
HEAT	STANDBY	OFF	AUTO	DRYBULB	40 °C
VENT	CLOSED	OFF	AUTO	WETBULB	20 °C
				WOOD PROBE	15 °C
STATUS	STOPPED	DRYING MODE		STERILIZATION MODE	
FAN FWD HR(s)	2	TRENDS	DIAG	HOME	START
FAN REV HR(s)	2				

The **Trends** screen is accessed through the settings screen. In the Trends screen, the user can see real time data logging. This data logs the forward drybulb, reversing drybulb, wetbulb 1, wetbulb 2 and the wood probe temperature. The user can print the data log by simply pressing the print button after the printer is configured to work with the HMI.

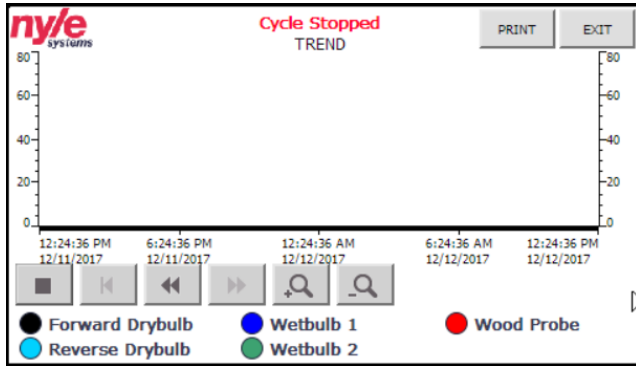

The **Diagnostics** screen is accessed through the settings screen. In the diagnostics screen, the user can see the temperature for wood probe 1, wetbulb 1, wetbulb 2, forward drybulb and reversing drybulb. The user can also see what calls the unit is getting. Displayed are the heat call, vent call and fan call. If the Estop is active, it will display here too. Another feature added to the diagnostic screen is the extra time feature. The user can add the desired amount of extra time in minutes if needed.

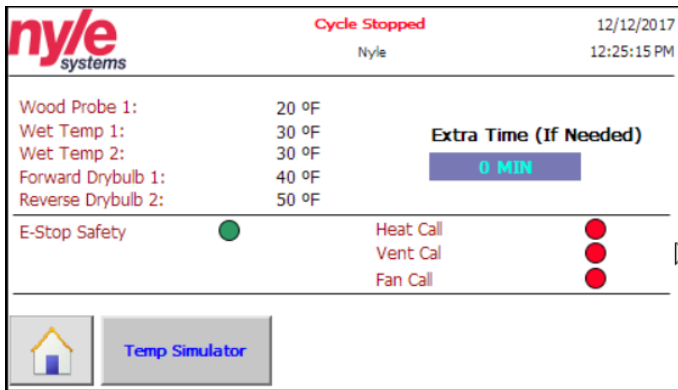

The **Schedule** screen is accessed through the home screen. The schedule screen is where the user can go to run a schedule. The user can add up to 20 steps in this schedule. To add a step, press the TABS UP button. To subtract a step, press the TABS DOWN button. The MAX TABS button adds 20 steps and the MIN TABS button gives the minimum amount of steps. You can also use the buttons on the right side to navigate through the steps. Once a schedule has been created, press the

START button in the bottom left corner and then click the SCHEDULE START button to start the schedule. After the schedule has complete each step, the unit will automatically shut down.

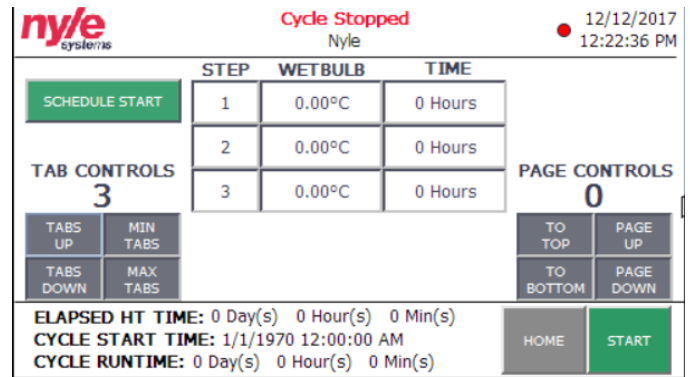

Data Logging

Starting a Data Log

Logging data with the NHT100 control is simple. The control is capable of storing up to 2 complete cycle logs in most cases. Once the data log storage space has been filled up on the HMI, an operator message will appear requiring the download and clearing of the logs through the retrieval system. The HMI will automatically save data logs every time the unit is in cycle.

Retrieving a Data Log

All data logs are stored on the HMI memory card as a CSV data log file. To obtain the data logs the kiln operator may either log into the HMI via the web interface or pull the SD card and copy over the files to a computer. To retrieve the data through the web interface, enter the IP address of the connected HMI into a web browser connected to the same local area network. Click "ENTER" to proceed into the default Siemens web interface. Login using supplied login from Nyle Systems. Click on "DATA LOGS" to view, download and clear the data logs stored on the HMI.

Setting up Remote Access on HMI

First, the user needs to make sure the unit on the same network as the device or devices that the user wants to use the remote access feature with. To get the unit online, run an Ethernet cable that is plugged into your network to the unit's PLC. Plug the Ethernet cable into the bottom left corner of the PLC. There will be one Ethernet cable already plugged in. Plug the Ethernet cable in next to the one that is already plugged in. This will connect the unit to the LAN. The HMI screen will be configured to use remote access when shipped. However, if you need to setup remote access on the HMI screen, follow the steps below.

1. Once you have a program downloaded to the HMI and it is ready to setup, go into the control menu by pressing the top right corner of the screen on the clock.

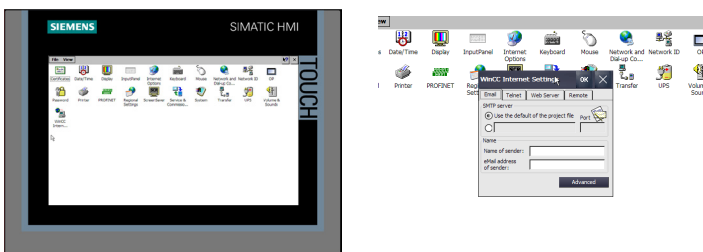

2. When you are in the control menu, click on WinCC. Choose remote and change the settings.

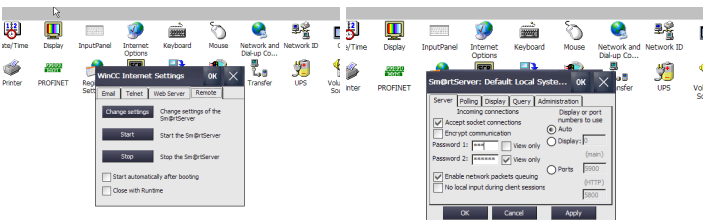

3. Choose the password one box and set the password to 100. Apply and choose yes.
4. Check the box that reads start automatically.
5. Press the start button and press OK. You will now be able to remote access to this HMI.

To remote into the HMI screen from another device, the user will need to install a program called VNC Viewer. The link for this program is posted below.

<https://www.realvnc.com/en/connect/download/viewer/>

After VNC Viewer is installed, the user will need to set-up a connection to the HMI screen. To do this, enter the IP Address of your HMI screen in the search bar at the top of the window in VNC Viewer. The search bar will read Enter a VNC Search address or search. This is where the user will enter in the IP address and press enter.

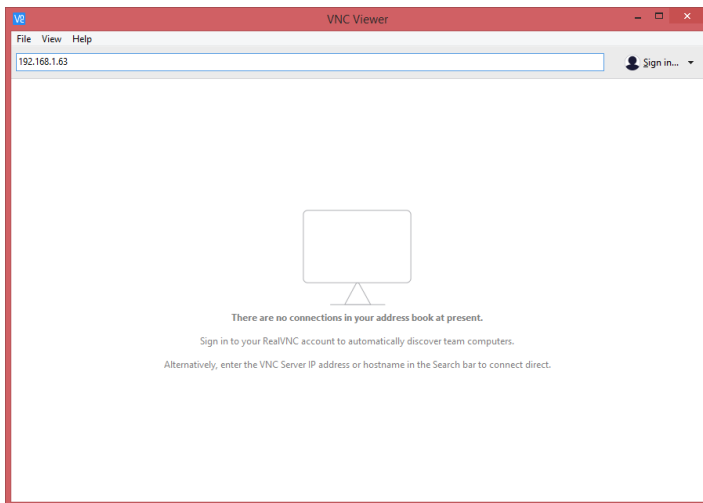

When the enter key is pressed, a window will pop up asking for a password. The password will always be 100.

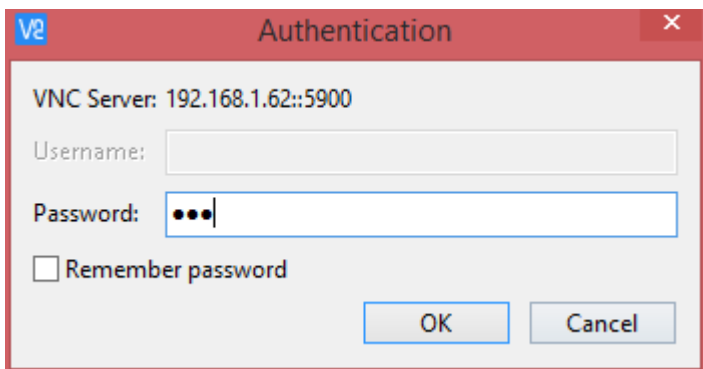

Type in 100 and then press OK or enter. This will bring up the same screen that is displayed on the HMI screen and the user will be able to monitor or change values as the user would be able to on the HMI screen.

Input Control Wiring

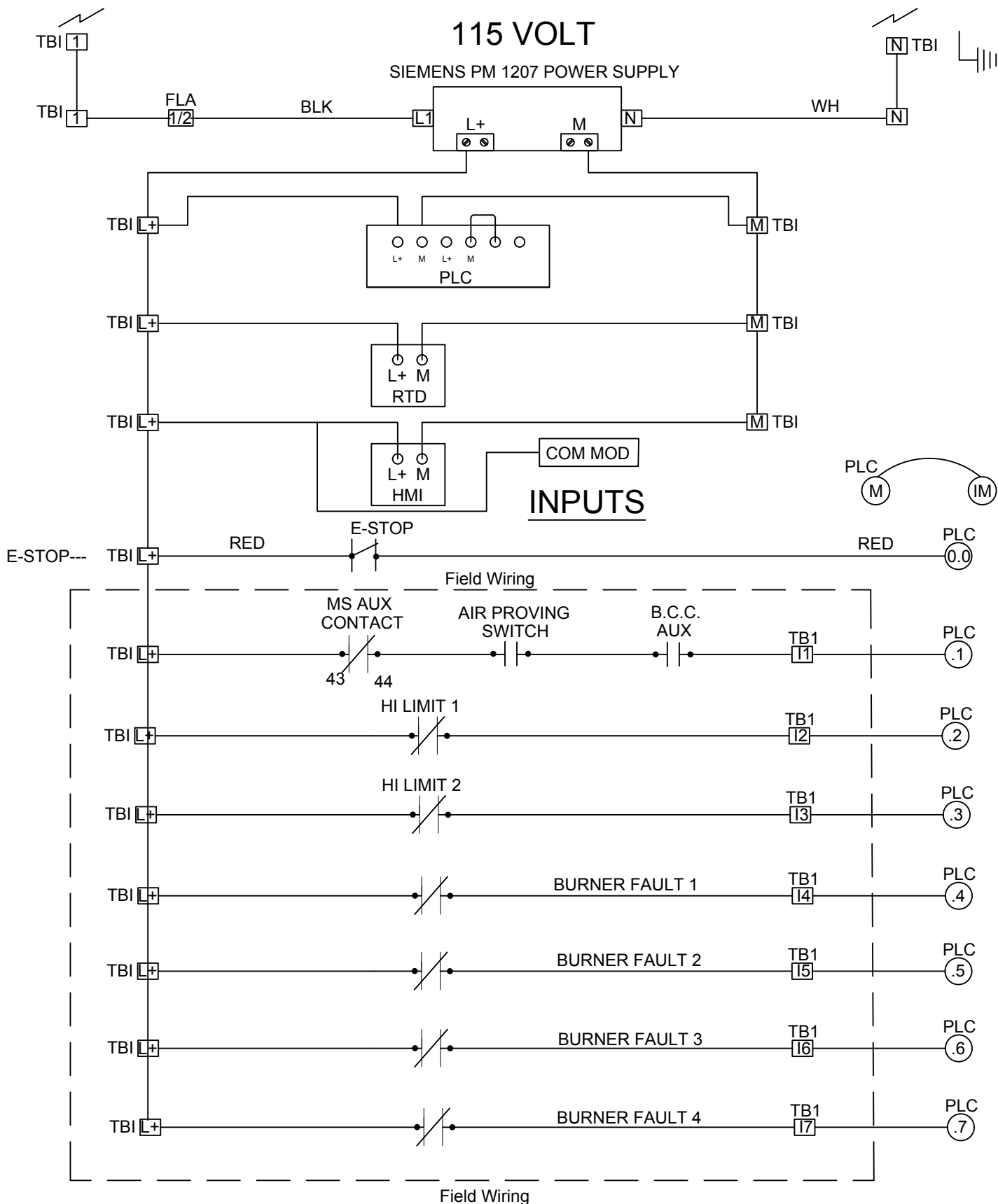

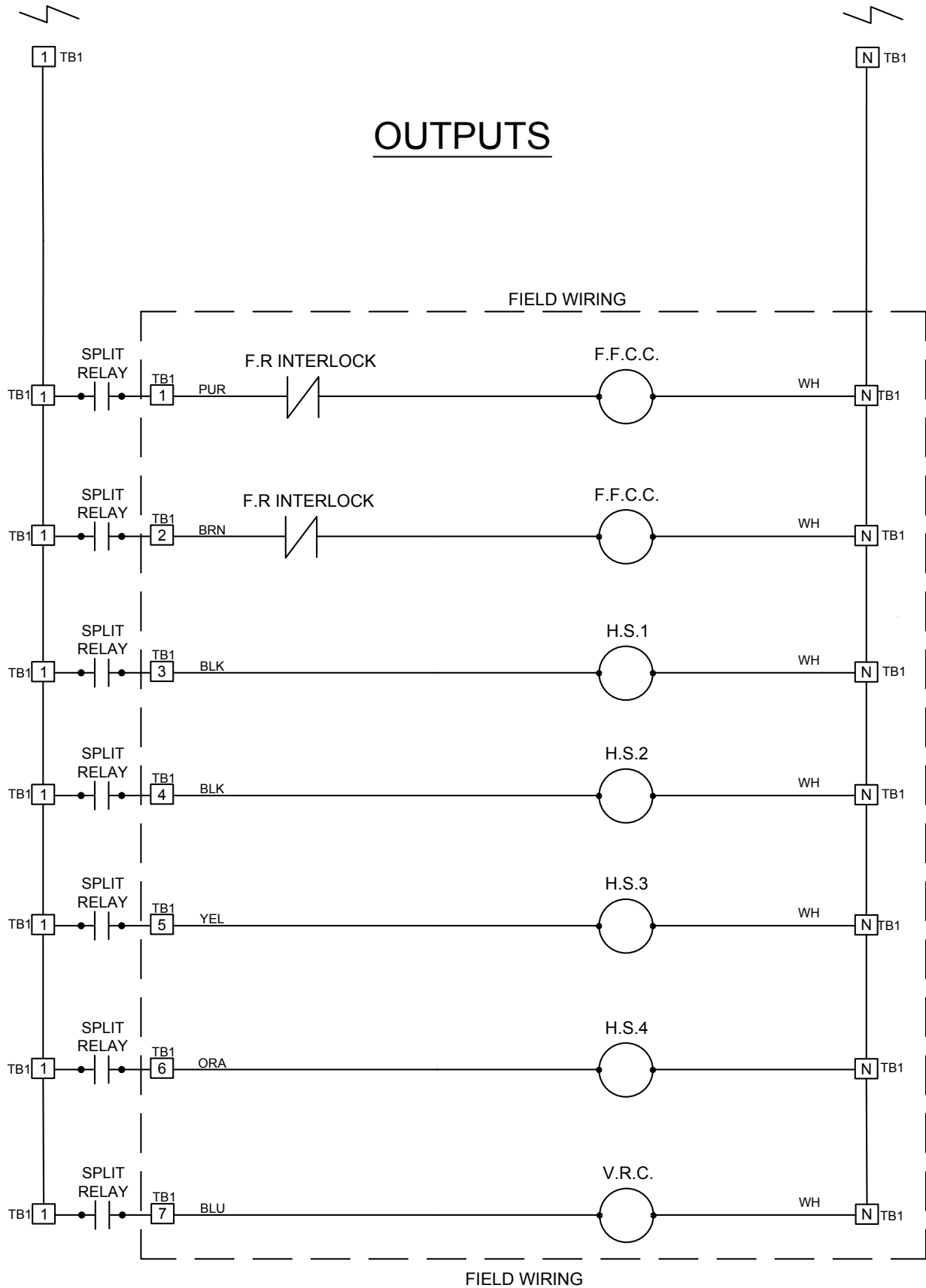

RTD SENSOR INPUTS

LG 46

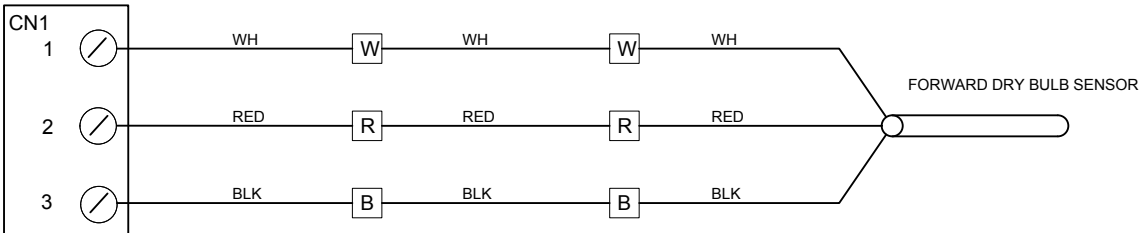

LG 46

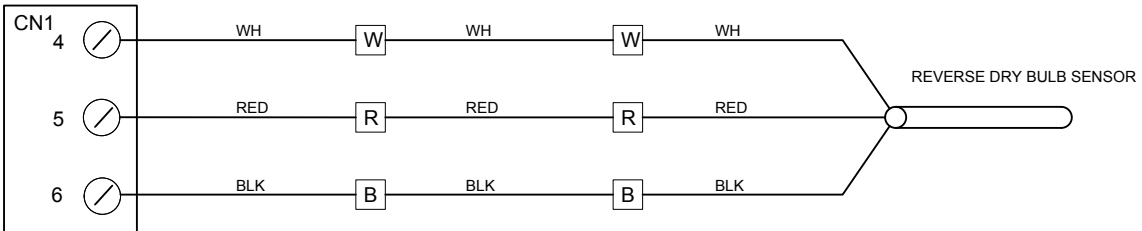

LG46

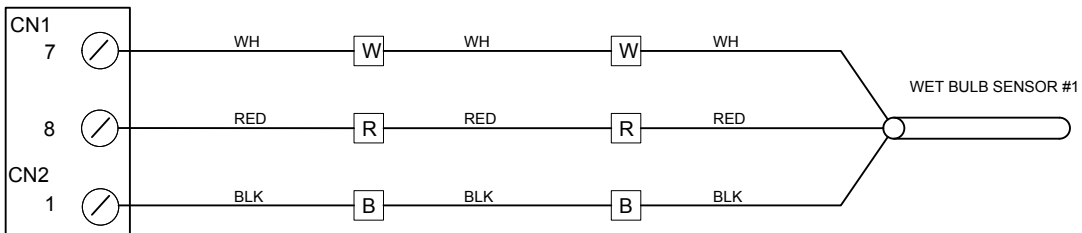

LG 46

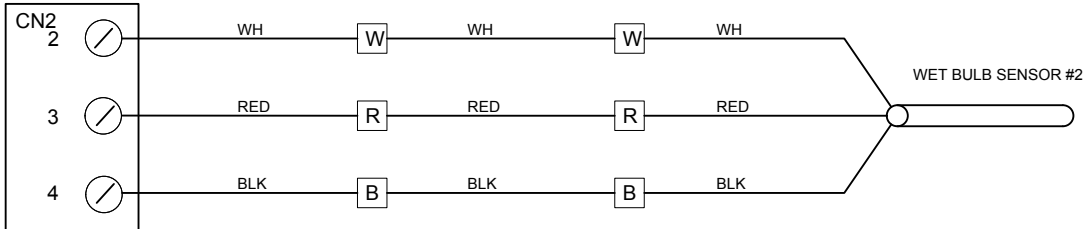

LG 46

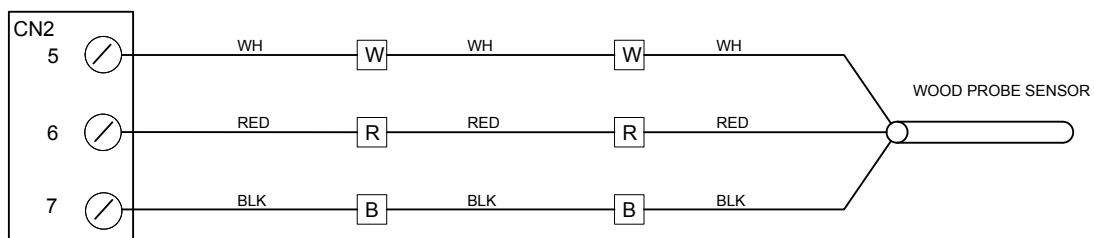



© Nyle Systems LLC
NSC100 HT Canadian Manual Version 1.2